



Our Ideas. Your Home

**Instructions for Installation and Use**  
**50cm Free Standing Eye-level Gas Cooker**

**HL500G**



**NOTE: This appliance is fitted with a battery powered ignition system (the battery provided). Should the ignition system start to spark slowly - or not at all, the battery will need replacing. See the section on battery replacement.**

To the Installer

Before installation fill in the product details on the back cover this book.  
The information can be found on the rating plate.

To the User

You must read the instructions prior to installing and using the appliance and then retain them for future reference.

---

## Contents

---

Introduction	3
Installation	4
Installation of Eye-Level Grill	8
Burner and Nozzle Specifications	10
Safety Information	11
Features	13
Control Panel	14
Use of hotplates	15
Grilling	16
Oven	17
Oven cooking charts	18
Care and Cleaning / Battery Replacement	19
Cooking Results Not Satisfactory?	20
Something Wrong With Your Cooker?	21
Technical Characteristics	22
After Sales Service	26
Hotpoint Guarantee	27
Key Contacts	Back Cover

**You must read these instructions prior to using your appliance and retain them for future use.**

---

# Introduction

---

Your new appliance is guaranteed\* and will give lasting service. This guarantee is only applicable if the appliance has been installed in accordance with the installation instructions detailed in this booklet.

To help make best use of your cooking equipment, please read this booklet carefully.

The cooker is designed specifically for domestic use and responsibility will not be accepted for use in any other installation.

**When the cooker is first used an odour may be emitted,  
this will cease after a period of use.**

When first using the cooker ensure that the room is well ventilated (e.g. open a window or use an extractor fan) and that persons who may be sensitive to the odour avoid any fumes. It is suggested that any pets be removed from the room until the smell has ceased. This odour is due to temporary finish on oven liners and elements and also any moisture absorbed by the insulation.

**\* The guarantee is subject to the provisions that the appliance:**

- (a) Has been used solely in accordance with the Users Instruction Book.**
- (b) Has been properly connected to a suitable supply voltage as stated on the rating plate attached to this equipment.**
- (c) Has not been subjected to misuse or accident or been modified or repaired by any person other than the authorised employee or agent.**
- (d) Has been correctly installed.**

- 1** This appliance is intended for nonprofessional use within the home.
- 2** These instructions are only for those countries whose symbols appear in the booklet and on the serial no. plate of the appliance.
- 3** **This owner's manual is for a class 1 appliance (insulated) or class 2, subclass 1 appliances (installed between two cabinets).**

---

# Installation

---

**The appliance must only be installed by a competent person. In the UK, CORGI registered installers undertake to work to safe and satisfactory standards.**

Before moving your cooker check that it is cool, and switch off at the cooker control unit.

Splashplate optional, apply to Parts Department (see Back Cover for contact number.)

The following instructions should be read by a qualified technician to ensure that the appliance is installed, regulated and technically serviced correctly in compliance with current regulations.

**Important: remember to unplug the appliance from the mains before regulating the appliance or carrying out any maintenance work.**

## Positioning

**Important:** this unit may be installed and used only in permanently ventilated rooms according to the British Standards Codes Of Practice: B.S. 6172/B.S. 5440, Par. 2 and B.S. 6891 Current Editions. The following requirements must be observed:

- The cooker should not be installed in a bed sitting room with a volume of less than 20m<sup>3</sup>. If it is installed in a room of volume less than 5m<sup>3</sup> an air vent of effective area of 110cm<sup>2</sup> is required, if it is installed in a room of volume between 5m<sup>3</sup> and 10m<sup>3</sup> a supplementary airvent area of 50cm<sup>2</sup> is required, if the volume exceeds 11m<sup>3</sup> no airvent is required. However, if the room has a door or a window which opens directly to the outside no air vent is required even when the volume is between 5m<sup>3</sup> and 11m<sup>3</sup>.
- During prolonged use of the appliance you may consider it necessary to open a window to the outside to improve ventilation.
- If there are other fuel burning appliances in the same room, B.S.5440 Part 2 Current Edition, should, be consulted to determine the requisite air vent requirements.

## Installation of the cooker

For a correct installation of the cooker the following precautions must be followed:

The height of the cooker can be adjusted by means of adjustable feet in the plinth (900mm - 915mm). Adjust the feet by tilting the cooker from the side. Then install the product into position.

**NOTE: This appliance must not be fitted on a platform.**

The cooker is designed to fit between kitchen cabinets spaced 500mm apart. The space either side need only be sufficient to allow withdrawal of the cooker for servicing. It can be used with cabinets one side or both as well as in a corner setting. It can also be used free-standing.

Adjacent side walls which project above hob level, must not be nearer to the cooker than 125mm and should be protected by heat resistant material. Any overhanging surface or cooker hood should not be nearer than 400mm. (Fig.A)

- The cooker may be located in a kitchen, a kitchen/diner or bed sitting room, but not in a bathroom or shower room.
- The hoods must be installed according to the requirements in the hood handbook.
- The wall in contact with the back of the cooker must be of flameproof material.
- The cooker is fitted with a safety chain that must be attached to a hook, secured to the wall behind the appliance.

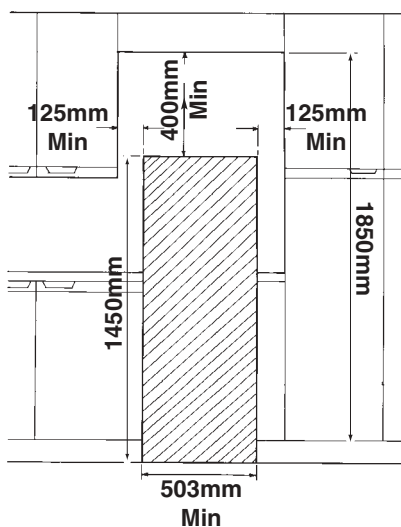
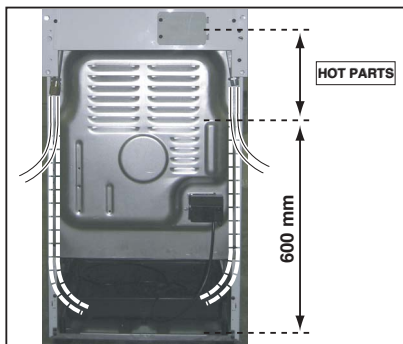

Fig. A

### Gas connection

The cooker should be connected to the gas-supply by a corgi registered installer. During installation of this product it is essential to fit an approved gas tap to isolate the supply from the appliance for the convenience of any subsequent removal or servicing. Connection of the appliance to the gas mains or liquid gas must be carried out according to the prescribed regulation in force, and only after it is ascertained that it is adaptable to the type of gas to be used. If not, follow the instructions indicated in the paragraph headed "Adaptation to different gas types". On some models the gas supply can be connected on the left or on the right, as necessary; to change the connection, reverse the position of the hose holder with that of the cap and replace the gasket (supplied with the appliance). In the case of connection to liquid gas, by tank, use pressure regulators that conform to the regulation in force. The gas supply must be connected to the left of the appliance. Be sure that the hose does not pass through the rear of the cooker touching hot parts.



**Important:** make sure the supply pressure conforms with the values shown in the table entitled "Characteristics of the burners and nozzles". **When the cooker is installed between cabinets (recessed), the gas connection must be effected by an approved flexible hose with bayonet fitting (BS 669 Current Edition). The gas inlet for the cookers is a threaded G 1/2 gas female fitting.**

### Connecting the gas supply

To make the connection, a flexible hose should be used corresponding to the current gas regulations which are:

- the hose must never be at any point in its length in contact with the "hot" parts of the cooker;
- the hose must never be longer than 1,5 metre;
- the hose must not be subject to any tension or torsional stress and it must not have any excessively narrow curves or bottlenecks;
- the hose must be easy to inspect along its entire length to check its condition;
- the hose must always be in good condition, never attempt to repair.

**Important:** the installation must comply with gas safety (installation and use) regulations 1984. In all cases for the above, by law, a qualified, corgi approved engineer must be called for installation.

**Important:** Before using the oven, position the oven burner deflector "A" (provided with the appliance) in the correct place by inserting the lower tab into the support slot (see figure).

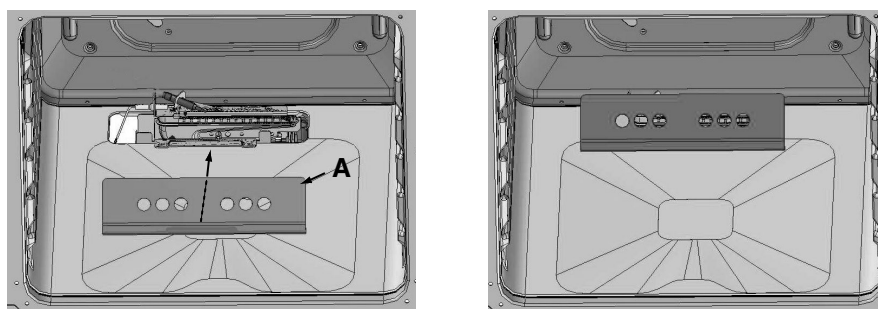

### Disposing of the appliance

When disposing of the appliance please remove the plug by cutting the mains cable as close as possible to the plug body and dispose of it as described above.

### Adapting the cooker to different types of gas

In order to adapt the cooker to a different type of gas with respect to the gas for which it was produced (indicated on the label attached to the lid), follow these steps:

- a) replace the hose holder mounted on the appliance with that supplied in the bag of "cooker accessories".
- b) Replacing the burner nozzles on the hob:
  - remove the grids and slide the burners from their housings;
  - unscrew the nozzles using a 7 mm socket spanner, and replace them with nozzles for the new type of gas

(see table 1 “Burner and nozzle characteristics”).

- replace all the components by repeating the steps in reverse order.

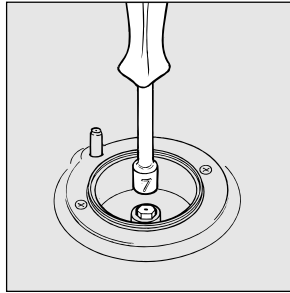

**c) Minimum regulation of the hob burners:**

- turn the tap to minimum;
- remove the knob and adjust the regulation screw, which is positioned in or next to the tap pin, until the flame is small but steady.

**N.B.:** in the case of liquid gas, the regulation screw must be screwed in to the bottom.

- check that the flame does not turn off when you turn the tap quickly from high to low.

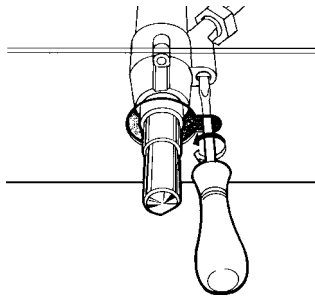

**d) Regulating the primary air of the burners:**

The primary air of the burners requires no regulation.

**Adapting to different types of gas**

In order to adapt the oven to a different type of gas with respect to the gas for which it was manufactured (indicated on the label), follow these simple steps:

**a) Replacing the oven burner nozzle**

- open the oven door fully
- pull out the sliding oven bottom
- unscrew the burner fastening screws

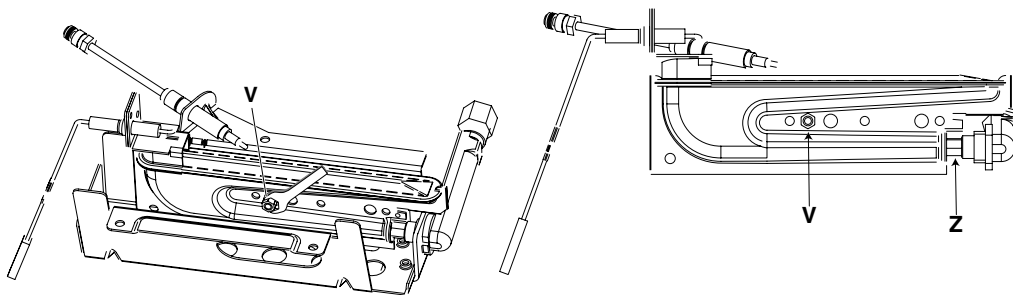

- remove screw “V” and then the oven burner;
- Unscrew the oven burner nozzle using the socket spanner for the nozzles “Z”, or a 7 mm socket spanner, and replace it with a nozzle suited to the new type of gas (see Table 1).

**Take particular care handling the spark plug wires and the thermocouple pipes.**

- Replace all the parts, following the steps described above in the reverse order.

**b) Minimum regulation of the gas oven burner with thermostat:**

- light the burner as described in the paragraph “the oven knob” of the instruction booklet.
- turn the knob to **Max** for about 10 minutes and then turn the knob to the **Min** setting;
- remove the knob;

- regulate the screw positioned outside the thermostat pin until the flame is small but steady.  
**N.B.:** in the case of liquid gas, the regulation screw must be screwed in to the bottom.

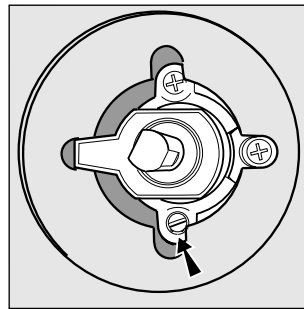
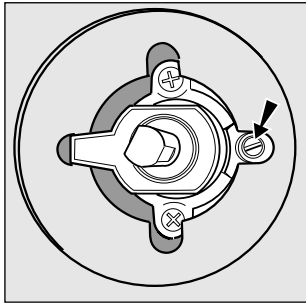

- check that the burner does not turn off **when you turn the knob from Max to Min** and when you open and close the oven door quickly.

### Adapting the gas grill to different types of gas

Replacing the nozzle of the grill burner:

- Loosen the screws along the perimeter to remove the rear protection (see diagram)

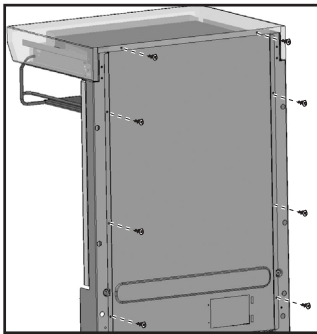

- remove screw "V" and then the grill burner;

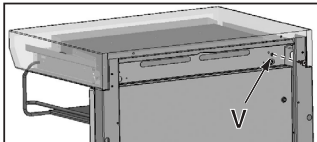

- Unscrew the grill burner nozzle using the socket spanner for the nozzles, or a 7 mm socket spanner, and replace it with a nozzle suited to the new type of gas (see Table 1).  
**Take particular care handling the spark plug wires and the thermocouple pipes.**

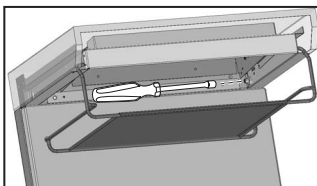

- Replace all the parts, following the steps described above in the reverse order.  
**N.B.:** No adjustment is needed for minimum setting.

### Important

On completion of the operation, replace the old rating sticker with one indicating the new type of gas used. This sticker is available from our Service Centres.

### Note

Should the pressure of the gas used be different (or vary) from the recommended pressure, it is necessary to fit a suitable pressure regulator onto the inlet pipe in compliance with current National Regulations relative to "regulators for channelled gas".

---

## Installation of Eye-Level Grill

---

1. Unpack the product.
2. Unscrew the lid which protects the gas supply connection attachment for the Grill.

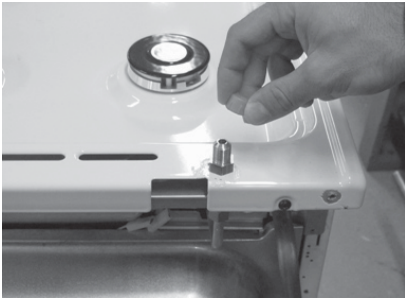

3. Remove the rear cover protecting the Grill assembly, which is fixed in place with 6 screws (see photograph).

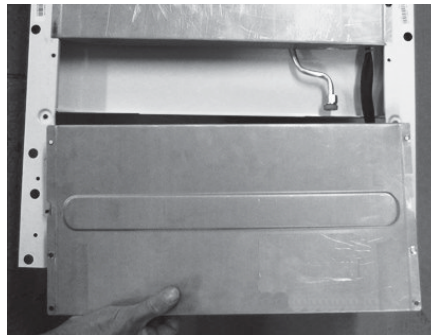
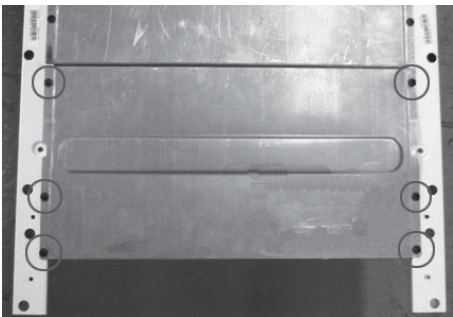

4. Join the Grill assembly to the cooker. To do this, it will be necessary to "jump" the gas attachment by folding the Grill assembly to 45° (see photograph).



5. Fix the Grill assembly to the cooker using three screws on the right-hand side and three screws on the left-hand side as shown in the photograph, using the screws supplied.

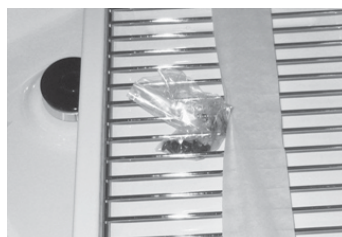
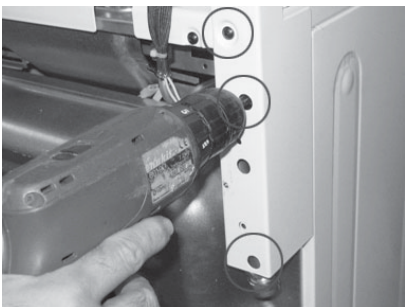



6. Join the Grill hose attachment to the cooker attachment (using a torque wrench setting of  $11 \pm 2$  Nm).



7. Connect the appliance electrically using the fastons on the rear part of the cooker (it makes no difference in which order these are connected).

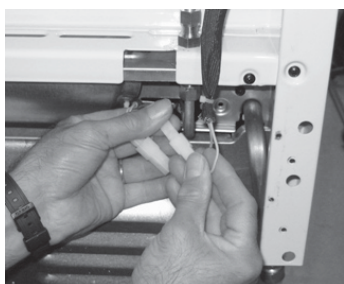

8. Replace the rear cover and fix it in place using the same screws (6) as removed previously in step 3 of this procedure.



# Burner and Nozzle Specifications

Burner	Diameter (mm)		Thermal Power kW (p.c.s.*) Nominal	Liquid Gas					Natural Gas		
				Thermal Power kW (p.c.s.*) Reduced	By-Pass 1/100 (mm)	Nozzle 1/100 (mm)	Flow* g/h		Thermal Power kW (p.c.s.*) Reduced	Nozzle 1/100 (mm)	Flow* l/h
Fast (Large)(R)	100	94	3,00	0,70	41	87	218	214	0,70	128	286
Semi Fast (Medium)(S)	75	69	1,90	0,40	30	70	138	136	0,40	104	181
Auxiliary (Small)(A)	51	46	1,00	0,40	30	52	73	71	0,40	76	95
Oven	-		2,60	0,60	36	75	189	186	0,60	123	248
Grill	-		3,60	2,40	90	94	262	257	1,40	140	343
Supply Pressures	Nominal (mbar)						28-30	37	20		
	Minimum (mbar)						20	25	17		
	Maximum (mbar)						35	45	25		

\* At 15°C and 1013 mbar- dry gas

\*\* Propane P.C.S. = 50,37 MJ/Kg

\*\*\* Butane P.C.S. = 49,47 MJ/Kg

Natural P.C.S. = 37,78 MJ/m<sup>3</sup>

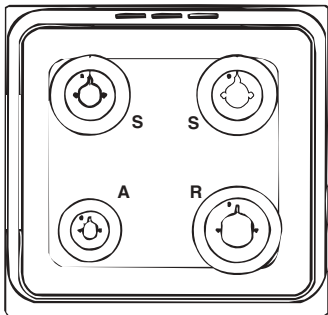

**HL500G**

---

## Safety Information

---

**When used properly your appliance is completely safe but as with any electrical product there are certain precautions that must be observed.**

**PLEASE READ THE PRECAUTIONS BELOW BEFORE USING YOUR APPLIANCE.**

### Always

- Remove all packing from inside the oven and grill compartments before switching on for the first time.
- Understand the controls prior to using the appliance.
- Keep children away from the appliance when grilling as the surfaces will get extremely hot during and after use.
- Turn controls **off** when you have finished cooking and when not in use.
- Stand back when opening an oven door to allow any build up of steam or heat to disperse.
- Use dry good quality oven gloves when removing items from the oven/grill.
- Place pans centrally over the hotplate making sure handles are kept away from the edge of the hob and cannot become heated by other hotplate/pans.
- Take care to avoid heat/steam burns when operating the controls.
- Turn off the electricity supply at the wall switch before cleaning and allow the appliance to cool.
- Make sure the shelves are in the correct position before switching on the oven.
- Keep the oven and grill doors closed when the appliance is not in use.
- Take care when removing items from the grill when the lower oven is on as the contents will be hot.
- Keep the appliance clean, as a build up of grease or fat from cooking can cause a fire.
- Follow the basic principles of food handling and hygiene to prevent the possibility of bacterial growth.
- Keep ventilation slots clear of obstructions.
- Refer servicing to a qualified appliance service engineer.
- Take care to avoid touching heating elements inside the oven, as during use the oven becomes hot.
- Before operating the product, remove all plastic film from the sides of the appliance.
- The internal surfaces of the compartment (where present) may become hot.

---

## Safety Information

---

### Never

- Never line the interior of the oven with foil as this may cause the appliance to overheat.
- Never leave children unsupervised where a cooking appliance is installed as all surfaces will be hot during and after its use.
- Do not allow children or persons who are not familiar with the appliance to use it, without supervision.
- Never allow anyone to sit or stand on any part of the appliance.
- Never store items above the appliance that children may attempt to reach.
- Never leave anything on the hob surface when unattended and not in use.
- Never remove the oven shelves whilst the oven is hot.
- Never heat up unopened food containers as pressure can build up causing the container to burst.
- Never store chemicals/food stuffs, pressurised container in or on the appliance, or in cabinets immediately above or next to the appliance.
- Never place flammable or plastic items on or near the hob.
- Never fill a deep fat frying pan more than 1/3 full of oil, or use a lid.  
DO NOT LEAVE UNATTENDED WHILE COOKING.
- Never use the appliance as a room heater.
- Never use the grill to warm plates.
- Never dry any items on either the hob or oven doors.
- Never install the appliance next to curtains or other soft furnishings.
- Never use steam cleaners.

#### **SAFETY ADVICE IN CASE OF A CHIP-PAN FIRE**

In the event of a chip pan fire or any other pan fire.

1. TURN OFF THE COOKER APPLIANCE AT THE WALL SWITCH.
2. COVER THE PAN WITH A FIRE BLANKET OR DAMP CLOTH, this will smother the flames and extinguish the fire.
3. LEAVE THE PAN TO COOL FOR AT LEAST 60 MINUTES BEFORE MOVING IT. Injuries are often caused by picking up a hot pan and rushing outside with it.

**NEVER USE A FIRE EXTINGUISHER TO PUT OUT A PAN FIRE** as the force of the extinguisher is likely to tip the pan over.

**Never use water to extinguish oil or fat fires.**

# Features

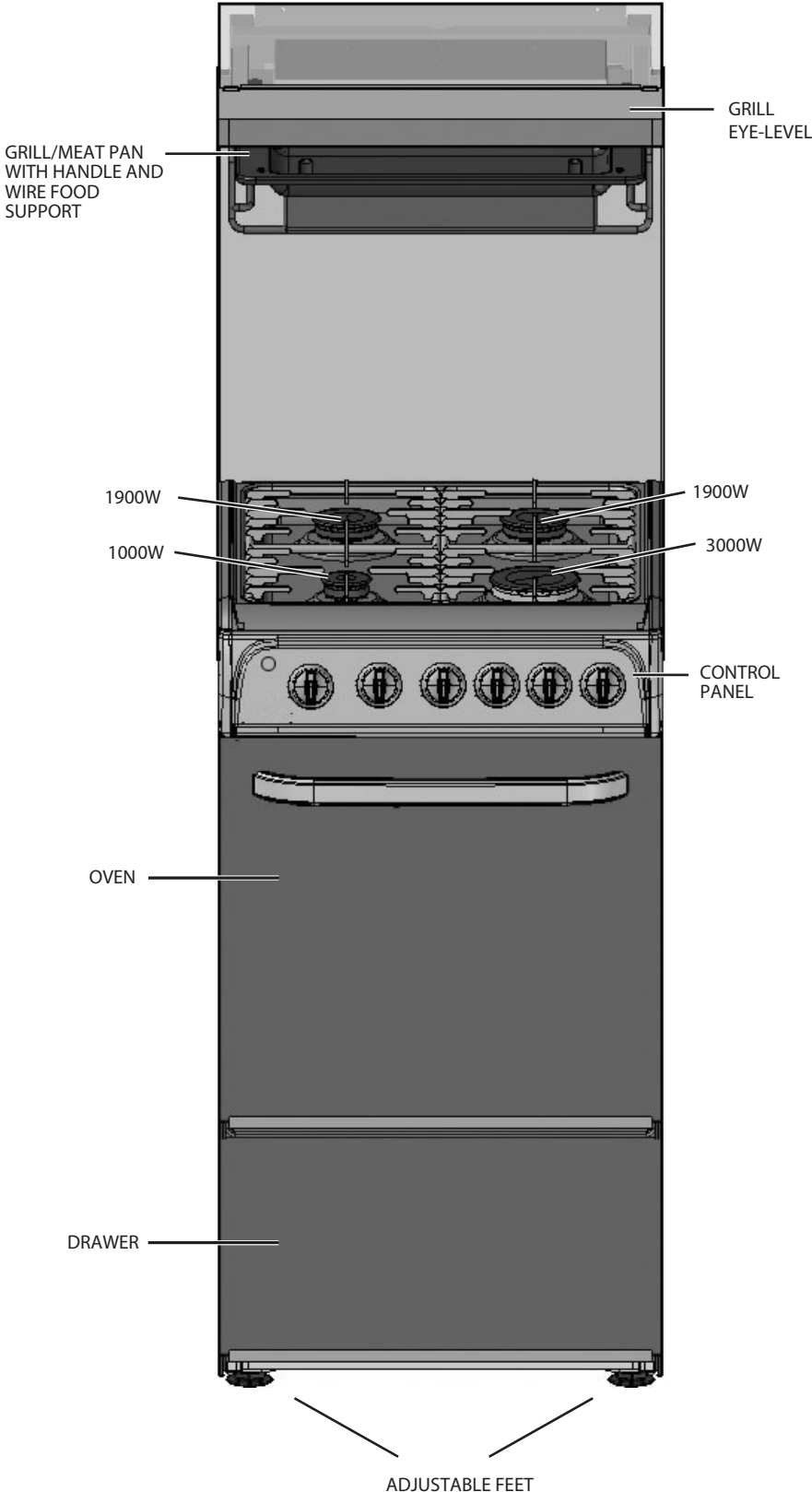

---

# Control Panel

---

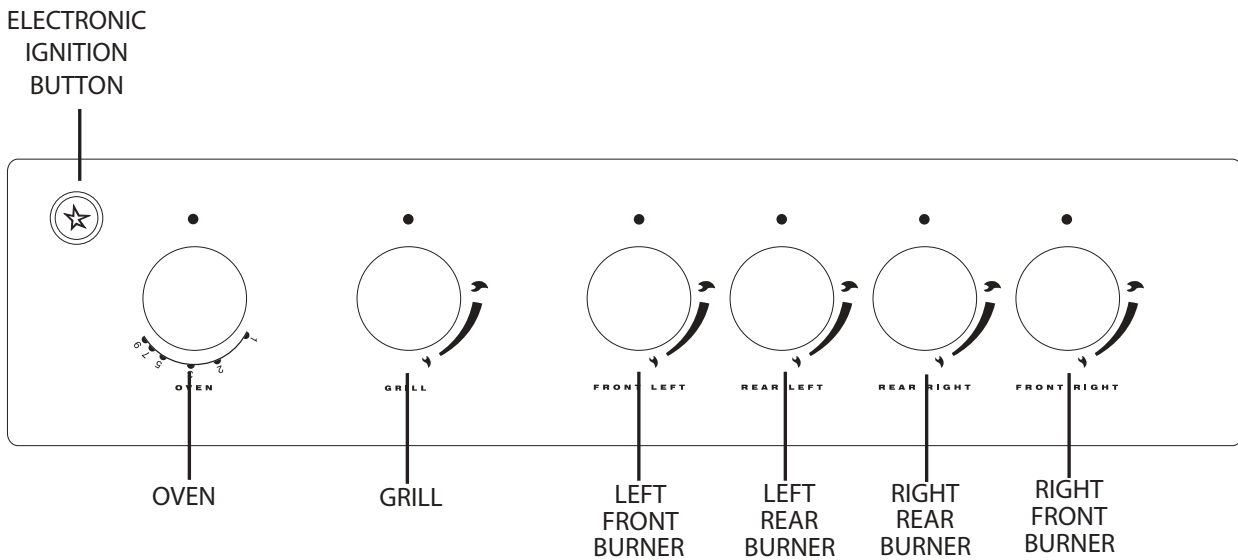

## Control Knobs for the gas burners

The position of the gas burner controlled by each one of the knobs is shown by a solid ring •. To light one of the burners, hold a lighted match or lighter near the burner and, at the same time, press down and turn the corresponding knob counter clockwise to the **maximum** 🔥 setting. Each burner can be operated at its maximum, minimum or intermediate power. Shown on the knob are the different symbols for off • (the knob is on this setting when the symbol corresponds with the reference mark on the control panel), for **maximum** 🔥 and **minimum** 🔥. To obtain these settings, turn the knob counter clockwise with respect to the off position. To turn off the burner, turn the knob clockwise until it stops (corresponding again with the • symbol).

## Electronic Ignition for the Gas Hob\*

This device operates when a slight pressure is applied to the button marked with ☆ symbol. To light a specific burner just press the button ☆ while pushing the corresponding knob all the way in and turning it counter-clockwise until it lights. **For immediate lighting, first press the button and then turn the knob.**  
**Important: Should the burner flames accidentally go out, turn off the control knob and wait at least 1 minute before trying to relight.**

\* (only available on certain models)

---

## Use of Hotplates

---

### Practical Advice on Using the Burners

To use the burners as efficiently as possible, some basic guidelines should be followed:

- Use cookware that is the right size for each burner (see table) in order to prevent the flame from spreading beyond the bottom of the cookware.
- Only use cookware with flat bottoms.
- As soon as the boiling point is reached, turn the knob to the lowest setting.
- Always use lids with pots and pans.

Burner	∅ Cookware diameter (cm)
Fast (R)	22 - 24
Semi Fast (S)	16 - 20
Auxiliary (A)	10 - 14

**N.B.:** On models equipped with a reduction grid, the grid should only be used with the auxiliary burner when cookware with a diameter of less than 12 cm is used.

1. To light a specific burner push the corresponding knob all the way in and turn it counter-clockwise to **maximum**  keeping it pressed down until the burner lights.
2. To turn the control knob anti-clockwise to the desired setting. Only turn the control knob between the large flame symbol and the small flame symbol for adjusting the setting.
3. To turn off, turn the control knob fully clockwise to the symbol **O**.

**DO NOT** use the hotplate unless all pan supports are in position.

**DO NOT** use mis-shapen pans which may be unstable.

**DO NOT** use round base woks directly on the pan supports.

**DO NOT** use the glass lid (if fitted) as a working surface.

Each burner is fitted with a spark ignitor for lighting the gas. To ensure rapid lighting of the burners every time they are used, the ignitors must be kept **clean and dry**. Remove any food spillage or cleaning materials from the electrode using a small nylon brush such as a tooth brush. Access to the electrode can be achieved by lifting off the loose burner parts carefully when the burners are cool.

When the hotplate burner bodies and caps are removed for cleaning, be careful not to drop any food particles or cleaning materials into the burner bases, to avoid the possibility of blocking the gas jets.

If aluminium based pans are used, a silvery deposit may appear on the top edge of the pan support fingers. See 'Care and Cleaning' section for cleaning information.

### SAFETY REQUIREMENTS FOR DEEP FAT FRYING

1. Never fill chip pans more than one third full with oil or fat.
2. Never leave oil or fat unattended during the heating or cooling period.
3. Never heat fat or fry with a lid on the pan.
4. Always dry food thoroughly before frying, and lower it slowly into the hot oil or fat. Frozen foods in particular will cause frothing and spitting if added too quickly.
5. Always keep the outside of the pan clean and free from streaks of oil or fat.

### HOW TO DEAL WITH A FAT FIRE

1. Do not move the pan.
2. Turn off the hotplate burners.
3. Smother the flames with a fire blanket or damp cloth to extinguish the fire. Do not use water or a fire extinguisher as the force of it may spread the burning fat or oil over the edge of the pan.
4. Leave the pan for at least 60 minutes before moving it.

---

# Grilling

---

**CAUTION: ACCESSIBLE PARTS WILL BECOME HOT WHEN THE GRILL IS USED - CHILDREN SHOULD BE KEPT AWAY.**

To operate the grill proceed as follows:

- Press the ignition button and then push in and turn the grill control knob anti-clockwise to the large flame symbol. Continue to press the ignition button until the spark lights the gas.
- Grill Pan Handle**
- Only turn the control knob between the large flame symbol and the small flame symbol for adjusting the setting.
  - To turn off, turn the control knob fully clockwise to the symbol **O**

**DO NOT** cover the grill pan or grid with aluminium foil as this can hold fat, intensify the heat and create a fire hazard.

Grilling can be started from cold but for best results preheat for approximately two minutes. Most cooking is done with the heat on full, but it may be desirable to reduce it for thicker pieces of meat, fish, chicken portions or for keeping food warm.

For au gratin dishes eg. Macaroni Cheese and meringue toppings eg. Baked Alaska, place the dish on the floor of the grill compartment. The base of the grill pan can be used for warming fruit garnishes on the reduced setting.

**NOTE:** Strong detergents used in dishwashers may damage the grill pan grid finish; clean in soapy water as described in CARE AND CLEANING section.

## Relighting the burner

In the event of the burner flames being accidentally extinguished, turn off the burner control and do not attempt to re-ignite the burner for at least one minute.



---

# Oven

---

The oven has different heat zones - the thermostat settings refer to the temperature on the middle shelf; above this shelf it is hotter and below it is cooler. Two shelves enable full use of the temperatures inside the oven.

Each shelf has a safety stop to prevent it from being pulled out too far when attending to food. Shelves are removed from the oven by pulling them out to the stop and then lifting them at the front to withdraw.

The grill pan without the handle can be used in the oven. The maximum size of baking tray that should be used is 300mm x 330mm (12" x 13").

- TO USE THE OVEN**
1. Place oven shelves in the chosen positions (refer to cooking charts).
  2. Press the ignition button and then push in and turn the oven control knob fully anti-clockwise. Continue to press the ignition button until the spark lights the gas.
  3. Turn the control knob clockwise to the required setting (refer to cooking chart). There is a delay of about six seconds whilst the safety device operates before the burner comes on full.
  4. To turn off, turn the control knob fully clockwise to the symbol 0.  
Never place dishes on the oven base over the burner.  
An odour may be noticed when first using the oven - this should cease after a short period of use.
  5. The oven temperature control markings are gas marked 0 to 9.  
The equivalent degrees Celsius (sometimes called Centigrade) are shown below as a guide.

Oven Setting	Temperature °C
1	145
2	160
3	175
4	190
5	205
6	222
7	240
8	250
9	260

## RELIGHTING THE BURNER

In the event of the burner flames being accidentally extinguished, turn off the burner control and do not attempt to re-ignite the burner for at least one minute

## COLD START COOKING

Anything requiring long slow cooking such as casseroles and rich fruit cakes can be put into a cold oven. Satisfactory results can also be obtained with creamed mixture, rich pastries or yeast mixtures, but for perfection we recommend preheating the oven for about 15 minutes.

## ROASTING OF LARGE POULTRY

The maximum weight of poultry that can be accommodated is 8kg (18 lbs) of suitable shape. It is important to check that the bird DOES NOT overhang the burner at the back of the oven.

## STORAGE AND RE-HEATING OF FOOD

It is vitally important to strictly adhere to the basic principles of food handling and hygiene to prevent the possibility of bacterial growth.

1. If food is to be frozen or not served immediately, cool it in a clean container as quickly as possible.
2. Completely thaw frozen food in the refrigerator before reheating.
3. Re-heat food thoroughly and quickly either on the hotplate or in a hot oven, Mk. 6, and then serve immediately.
4. Only re-heat food once.

## 'COOK CHILL' DISHES

These should always be placed in a pre-heated oven ideally on the first or second shelf position. Follow the packet instructions for cooking time.

## ALUMINIUM FOIL

If using Aluminium Foil:

1. Remember that it is important to increase the cooking time by one third.
2. Never allow the foil to touch the sides of the oven.
3. Never cover the oven interior with foil.
4. Never cover the oven shelves with foil.

# Oven Cooking Chart

The following times and setting are for guidance only. You may wish to alter the setting to give a result more to your satisfaction. When a different setting to that shown below is given in a recipe, the recipe instructions should be followed. Allow 15 minutes preheat for best results. Always turn the thermostat knob to Mark 9 before selecting the appropriate gas Mark. Shelf position 1 is the highest.

Food	Gas Mark	Shelf Position	Approx. Cooking Time and Comments
<b>Fish</b>			
Oily and white fish	3 or 4	4	25-60 mins. depending on recipe
<b>Meat and Poultry</b>			
Beef	4 or 5	4	25-30 mins per 450g (1 lb) + 25 mins. extra
Ham	5	4	40 mins per 450g (1 lb) covered in foil plus 40 mins. extra
Lamb	5	4	30 mins per 450g (1 lb) + 30 mins extra
Pork	5	4	40 mins per 450g (1 lb) + 40 mins extra
Chicken	5	4	25 mins per 450g (1 lb) + 25 mins extra
Duckling & Goose	5	4	25 mins per 450g (1 lb) + 25 mins extra
Turkey	4 or 5	4 or 5	15-20 mins per 450g (1 lb) + 20 mins
Casseroles	3	3or4	2-6 hrs. depending on cut of meat
<b>Vegetables</b>			
Baked jacket potatoes	4 or 5	3	1½ - 3 hrs. until soft, depending on size
<b>Puddings</b>			
Milk Puddings (500ml/1 pt)	3	4	1¼-2½ stand dish on baking tray and started with warm milk
Baked Custard (500ml/1 pt)	3	4	45-60 mins. bain-marie
Baked Sponge Puddings	4	3	40-50 mins
Baked Apples	3	3	30-45 mins depending on type and size of apples
Meringue Topped Puddings	1	3or4	15 mins or until "tinged" with brown
Apple Tart (1 x205mm/8")	6	2	45-60 mins
Fruit Crumble	5	2	35 -45 mins
<b>Cakes, Pastries &amp; Biscuits</b>			
Small Cakes 2 trays	5	2 and 4	15-25 mins.
1 tray	5	2	15-22mins.
Victoria sandwich (2 x 7")	4	2 and 4	20-30 mins
Swiss Roll (3 egg quantity)	5	2	15-20 mins.
Meringues	1	3	2-3 hrs
Christmas cake (1 x 205mm / 8")	2	3	Time depending on recipe
Madeira cake (1 x 180mm / 7")	4	4	1¼-1½ hrs.
Rich Fruit cake (1 x 180mm / 7")	2	4	Time depending on recipe
Scones	7	1 and 3	10-20 mins.
Shortbread (1 x 180mm / 7")	2	3	55 -65 mins.
Biscuits	4	1 and 3	10-20 mins.
Shortcrust Pastry	6	2	15 - 60 mins depending on use.
Rich Short Crust	5	1 and 3	20-30 mins.
Flaky/Puff Pastry	7	2	10-30 mins.
Choux Pastry	6	2	20-30mins.
<b>Yeast Mixtures</b>			
Bread - rolls	7	2 and 4	20-30 mins.
<b>Miscellaneous</b>			
Yorkshire Pudding:- large	7	1	30-40 mins
individual	7	2	20-30mins

When baking with two trays or tins on two levels, the top tray is removed first and the lower tray moved up to the top position for a few minutes longer.

## Soft Margarine -

Use the oven settings recommended by the margarine manufacturer and **not** those indicated on the cooking chart.

---

## Care and Cleaning

---

<b>Grill</b>	Remove the grill pan and the wire grid food support, it is best to wash these items immediately after use to prevent stains from being burnt on when used again. Wipe out the Grill compartment, use a fine steel wool soap pad to remove stubborn stains from the grill runners and the floor of the compartment. Wipe over the control panel with a damp cloth and polish with a dry cloth.
<b>Control Panel</b>	<b>Do not use</b> cream cleaners, oven cleaners or aerosols, scouring pads or abrasive powder for cleaning the plastic knobs as damage will occur.
<b>Decorative Trims</b>	It is advisable to clean the decorative trims regularly to prevent any build up of soiling. The recommended method of cleaning is to wipe over the trims with a soft cloth wrung out in warm water or mild non-abrasive cleaner. (If in doubt try the cleaner on a small area of trim which is not noticeable in normal use). Then, after wiping with a cloth wrung out in clear water, dry with a soft clean cloth.
<b>Doors</b>	Wipe over the outer door glass panels with a cloth wrung out in warm soapy water, then after wiping with a cloth wrung out in clear water, dry with a soft clean cloth. <b>Ensure that glass doors are not subjected to any sharp mechanical blows.</b> <b>Glass Inner Door Panel (where fitted)</b> – open the door fully and unscrew the two screws securing the glass panel, taking care not to allow the glass to fall. The glass panel may now be washed at the sink. Stubborn stains can be removed by using a fine steel wool soap pad. <b>Ensure the glass panel is not subjected to any sharp mechanical blows.</b> Take particular care not to damage the inner surface which is coated with a heat reflective layer. After cleaning, rinse and dry with a soft cloth. For slight soiling the inner glass panel may be cleaned, while still warm, without removing it from the door. Warning: Oven must not be operated with inner door glass removed. <b>Take care</b> during cleaning not to damage or distort the door seals. Do not lift the door seal from the oven chassis, if necessary remove the seal by carefully unhooking the corner clips. <b>Take care</b> that the rating label edges are not lifted during cleaning, and furthermore that the lettering is not blurred or removed.
<b>Ovens</b>	Remove the rod shelves and grill pan. Use a fine steel wool soap pad to remove stubborn stains from the rod shelves, grill pan and the floor of the oven. Clean the glass part of the oven door using a sponge and a non-abrasive cleaning product, then dry thoroughly with a soft cloth. Do not use rough abrasive material or sharp metal scrapers as these could scratch the surface and cause the glass to crack.
<b>Oven Shelf Supports</b>	The shelf supports are removable and dishwasher safe. <b>To remove</b> hold the support at the front and pull away from the oven side, this can then be cleaned in a sink or a dishwasher. When removed it allows access to the oven side, which can be cleaned with warm soapy water. <b>To refit</b> the support, insert the longer leg into the rear fixing hole and push in the front leg.
<b>Replacing the Battery</b>	The battery is not covered by the guarantee. Use an alkaline AA battery. The battery holder is located in the plinth panel below the oven door. Open the oven door fully. Press the tag on the left hand side of the battery holder/cover and withdraw it just enough to get access to the battery. Fit the new battery with the end marked “+” on the same side of the battery holder as the red lead. Replace the battery holder by pushing it firmly into the hole in the plinth.

---

## Cooking Results Not Satisfactory?

---

Problem	Check
<b>Grilling</b> Uneven cooking front to back	Ensure that the grill pan is positioned centrally below the grill element.
Fat splattering	Ensure that the grill is not set to too high a temperature.
<b>Oven Baking</b> Uneven rising of cake	Ensure that the oven shelves are level by using a spirit level on the rod shelf and adjusting, using suitable packing e.g. wood, under the feet of the appliance. This should be checked both left to right and front to back. Ensure that the food is positioned centrally in the oven.
Sinking of cakes	The following may cause cakes to sink: 1. Cooking at too high a temperature. 2. Using normal creaming method with soft margarine.
Over/Under cooking Fast/Slow cooking	Refer to the cooking times and temperatures given in the oven temperature charts, however, it may be necessary to increase or decrease temperatures by 10°C to suit personal taste. Do not use utensils greater than 2¼ ins in height.
Uneven cooking of cakes	1. Too large baking sheet used. (See 'Cookery Notes') 2. Over loading of oven and always ensure even air gaps around baking tins.
Uneven rising of cake	Ensure that the shelf is level (see above) and that the food is positioned centrally in the oven.
Food is taking too long to cook	Only cook one item at a time to avoid overloading the oven.

# Something Wrong with your Cooker?

Before contacting your nearest Service Centre/Installer, check the problem guide below; there may be nothing wrong with your cooker.

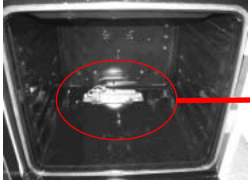
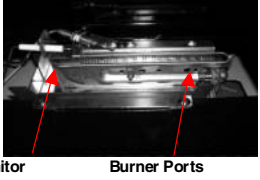
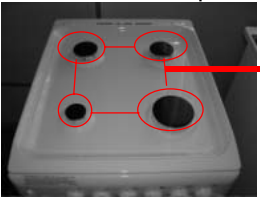
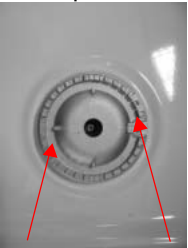
Problem	Check
<p><b>Ignition does not work</b></p> <p><b>Oven Cavity</b></p>  <p><b>Oven Burner</b></p>  <p><b>Ignitor</b>      <b>Burner Ports</b></p> <p><b>Hob Top</b></p>  <p><b>Hotplate Burner</b></p>  <p><b>Burner Ports</b>      <b>Ignitor</b></p>	<p><b>If all burners fail to ignite:</b> Check that sparks appear at the burners; A clicking noise should be heard.</p> <p><b>If not</b> Check that the plug is plugged in to a 13amp Electric socket and the supply is switched on.</p> <p><b>If all burners still fail to ignite</b> Check and replace if necessary the 13amp fuse</p> <p><b>If only one burner fails to ignite</b> Check that the burner is dry and that spillage of food or cleaning fluid remains are not affecting the Ignitor or burner ports.  Clean away any debris with a dry nylon brush such as an old dry toothbrush. If a wire wool pad has been used for cleaning around the burner ensure the Ignitor is free from any stray strands. Any water on the burner should be dried with a cloth or kitchen towel.</p> <p>On the hotplate make sure that all burner parts are correctly seated</p>
<p><b>Oven Temperature seems too high or too low</b></p>	<p>Check that the temperature has been set in accordance with the temperature charts. It may be necessary to increase or decrease the recommended temperature by 10 C to suit your taste</p>
<p><b>Oven does not cook evenly.</b></p>	<p>Check the temperature and shelf position are as recommended in the temperature charts</p> <p>Check that the Utensil being used in the oven allow sufficient air flow around them.</p> <p>Check that the cooker is level.</p>
<p><b>Hotplates are slow to boil or will not simmer</b></p>	<p>Check that your pans conform to the recommendations in these instructions.</p>
<p><b>Odour or smoke when using your new cooker</b></p>	<p>This is normal and should cease after a short period.</p>
<p><b>Condensation / Steam in the Oven After Use</b></p>	<p>Condensation and steam is a by product of cooking food with a water content. To help minimise always: A) Try to avoid leaving food in the oven to cool after being cooked B) Use a covered Utensil wherever possible</p>
<p><b>Condensation on the Wall at the Rear of the Cooker</b></p>	<p>Steam and/or condensation may appear from the vent at the rear of the appliance when using an oven, particularly when cooking foods with a high water content (Such as Oven Chips or Chicken). This is normal and any excess should be wiped off</p>

---

## Technical Characteristics

---

### Main Oven

Dimensions (HxWxD): 34x37,5x31 cm

Volume: 40 Litres

---

### Battery

1.5V Alkaline AA

---

### Burners:

Adaptable for use with all the types of gas indicated on the data plate.

---



**This appliance conforms with the following European Economic Community directives:**

- 90/396/EEC of 29/06/90 (Gas) and subsequent modifications (only for models which use gas);
- 93/68/EEC of 22/07/93 and subsequent modifications.
- 2002/96/EC

The European Directive 2002/96/EC on Waste Electrical and Electronic Equipment (WEEE), requires that old household electrical appliances must not be disposed of in the normal unsorted municipal waste stream. Old appliances must be collected separately in order to optimise the recovery and recycling of the materials they contain and reduce the impact on human health and the environment. The crossed out “wheeled bin” symbol on the product reminds you of your obligation, that when you dispose of the appliance it must be separately collected.

Consumers should contact their local authority or retailer for information concerning the correct disposal of their old appliance.

### Mains frequency and voltage of the electric section and characteristics of the gas section

Model	Gas section	
	Class	Rated power kW (1)
HL500G	II2H3+	14,00 (1018 g/h - G30) (1000 g/h - G31)

(1) The values in g/h refer to the capacities with liquid gas (Butane, Propane).











## After Sales Service

**"No company is better positioned to offer an after sales service on a Hotpoint appliance than us - the manufacturer"**

As part of our commitment to you, all Hotpoint appliances have the added benefit of a fully inclusive parts and labour guarantee for the first 12 months. In addition to this you also have the advantage of **free replacement parts for the first 5 years** when fitted by a Hotpoint engineer. When the 12 months parts and labour guarantee expires we offer the following after sales service options:

### Repair Service and Information Help Desk

UK: 08709 066066

[www.theservicecentre.co.uk](http://www.theservicecentre.co.uk)

Republic of Ireland: 1850 302 200

Note: Our operators will require the Model number and the Serial number of your appliance

Available 364 days a year with a fast, effective and value for money service. We have the largest white goods repair service in the UK with over 1200 of our own fully trained engineers. All repairs include a parts and labour guarantee for 12 months from the date of the repair.

If you require any information or have any questions about your appliance, our operators are on hand with help and advice.

All this ensures that you will receive the best available after sales service possible.

### Extended Warranties

UK: 08709 088 088

[www.theservicecentre.co.uk](http://www.theservicecentre.co.uk)

Republic of Ireland: 1850 502 200

Whether you have just one or a number of Hotpoint appliances in your kitchen, we offer two service cover plans to give you total peace of mind.

- Repair Protection Plan - FREE service repairs for a single Hotpoint appliance during the period of cover.
- Kitchen Cover - FREE service repairs for all your Hotpoint appliances less than 8 years old.

### Genuine Parts and Accessories UK: 08709 077 077

[www.theservicecentre.co.uk](http://www.theservicecentre.co.uk)

Republic of Ireland: (01) 842 6836

A wide range of genuine parts and accessories are available from our hotline or through our web site.

**Genuine parts and accessories, extended warranties and service repairs are all available on our web-site at:**



[www.theservicecentre.co.uk](http://www.theservicecentre.co.uk)



## Guarantee

**"Satisfaction guaranteed or your money back"**

We give you a unique 'satisfaction guaranteed' promise - **valid for 90 days** - after you have purchased your Hotpoint appliance. If there is a technical problem simply call Hotpoint Repair service or visit our web-site at [www.theservicecentre.co.uk](http://www.theservicecentre.co.uk) and where necessary, we will arrange for an engineer to call. If the technical problem is not resolved under this guarantee, **we will replace your machine or, if you prefer, give you your money back.**

All Hotpoint appliances carry a fully inclusive 12 month parts and labour guarantee as well as free replacement parts for the first 5 years (except microwaves, selected integrated appliances and cooker hoods, which have a one year guarantee) provided that they are fitted by a Hotpoint engineer.

### Guarantee terms and conditions

Your guarantee is only applicable in the United Kingdom or Republic of Ireland and is subject to the following provisions that your appliance:

- Has been installed and used correctly in accordance with this instruction booklet.
- Has been used solely for domestic purposes and is located on domestic premises (ie. not for commercial or trade use).
- Has been properly connected to a suitable electrical supply voltage as stated on the appliance rating plate.
- Has not been subject to misuse, accident, modified or repaired by anyone other than one of our own service engineers.

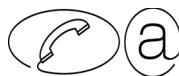

For pre purchase information on any other Hotpoint product call: 08701 50 60 70  
or visit: [www.hotpoint.co.uk](http://www.hotpoint.co.uk)

## Recycling & Disposal Information

As part of Hotpoint's continued commitment to helping the environment, Hotpoint reserves the right to use quality recycled components to keep down customer costs and minimise material wastage.

Please dispose of packaging and old appliances carefully.

To minimise risk of injury to children, remove the plug and cut mains cable off flush with the appliance. Dispose of these parts separately to ensure that the appliance can no longer be plugged into a mains socket.



## Key Contacts

### After Sales Service

Over 1200 trained specialists, directly employed by us, ensure that you can have complete confidence in both the appliances and services we offer.



### Repair Service and Information Desk

UK: 08709 066 066

(Open 8 to 8 Mon - Fri, 8 to 6 Sat, 10 to 4 Sun & Bank Holidays)

[www.theservicecentre.co.uk](http://www.theservicecentre.co.uk)

Republic of Ireland: 1850 302 200

Note: Our operators will require the following information:

Model number:

Serial number:

### Extended Warranties

UK: 08709 088 088

(Open 8 to 8 Mon - Sun)

[www.theservicecentre.co.uk](http://www.theservicecentre.co.uk)

Republic of Ireland: 1850 502 200

### Genuine Parts and Accessories

UK: 08709 077 077

(Open 8-30 to 5-30 Mon - Fri & 9 to 12 Sat)

[www.theservicecentre.co.uk](http://www.theservicecentre.co.uk)

Republic of Ireland: (01) 842 6836

Indesit Company UK LTD, Morley Way, Peterborough, PE2 9JB.

11/2007 - 19506499704